

Brass ball valve with free flow, DVGW approved.

This valve complies with the European standard EN 13828 and the working paper DVGW W 570, and is therefore approved for use with drinking water.

The special ball technology prevents bacteria from forming inside the valve if it is not in use for a long period of time (i.e. the valve is absolutely safe for drinking water).

Housing	Nickel-plated brass (outside), brass (inside)
Ball	Chrome-plated brass
Ball seal	PTFE
Stem seal	PTFE / EPDM / HNBR
Thread material	Brass
Hand lever	Aluminium
Operating temperature	-15 °C to 110 °C
Applications	Potable water, water
Standard thread	Thread acc. to DIN EN ISO 228-1

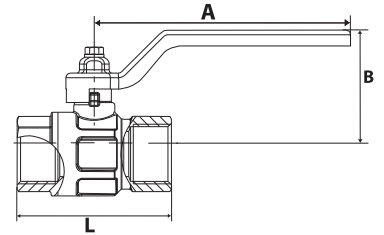

350.7703

Potable water ball valve with hand lever, female/female thread

Art. No.	Type No.	Thread	DN	PN bar	L mm	A mm	B mm
133161	350.7701	G 1/4	8	50	46.0	85.0	42.0
133162	350.7702	G 3/8	10	50	50.0	85.0	42.0
133163	350.7703	G 1/2	15	40	50.0	85.0	45.8
133164	350.7704	G 3/4	20	40	58.0	105.0	53.4
133165	350.7705	G 1	25	40	69.0	105.0	57.3
133166	350.7706	G 1 1/4	32	40	80.0	130.0	70.1
133167	350.7707	G 1 1/2	40	40	91.5	130.0	76.1
133168	350.7708	G 2	50	40	119.0	165.0	92.4





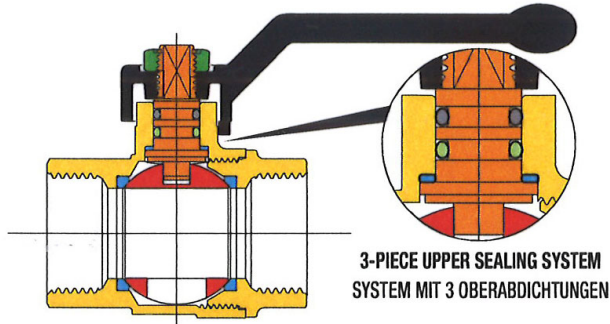



PRESSURE/TEMPERATURE DIAGRAM - DRUCK/TEMPERATURDIAGRAMM

SECTION / QUERSCHNITT



3-PIECE UPPER SEALING SYSTEM
SYSTEM MIT 3 OBERABDICHTUNGEN

LIST OF COMPONENTS: description/materials/treatments
TEILELISTE: Beschreibung / Werkstoffe / Behandlungen

Body and threaded end Gehäuse und Gewindemuffe		CW617N (Pb ≤ 2,2% DIN 50930T6)
Stem Betätigungsspindel		CW617N (Pb ≤ 2,2% DIN 50930T6)
Chromium pl. polished ball Blank verchromte Kugel		CW617N (Pb ≤ 2,2% DIN 50930T6)
Seats Dichtungen		PTFE
O-ring on the stem Oberer O-Ring Spindel		HNBR
O-ring under the stem Unterer O-Ring Spindel		EPDM PEROXIDE / PEROXID-EPDM
Operating device Betätigungselement		aluminium alloy / alu-Legierung
Fixing screw Befestigungsmutter		zinc plated steel / zinkstahl
Surface treatment Außenbehandlung	-	nickel plating outside, plain brass inside vernickelte Oberfläche, Rohe Messing innen